

Horizontal Side Slider Garage Door Screen

Series SS10

Inside Mount Configurations

4-Track Horizontal Side Slider

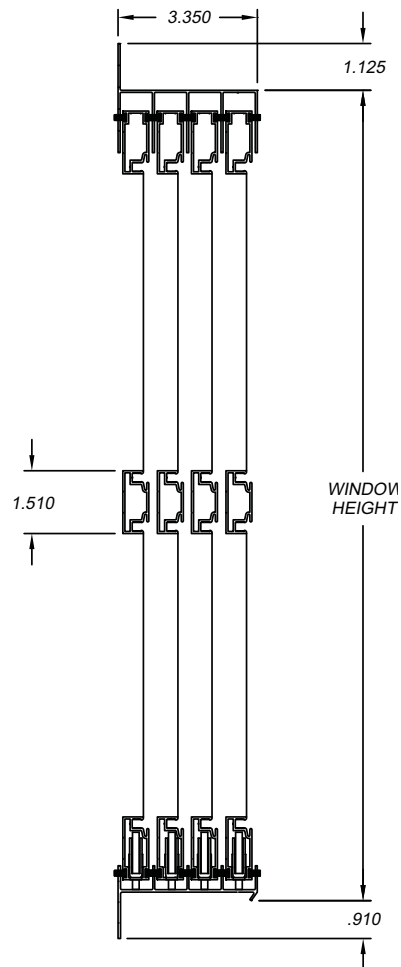

4-Track Horizontal Side Slider

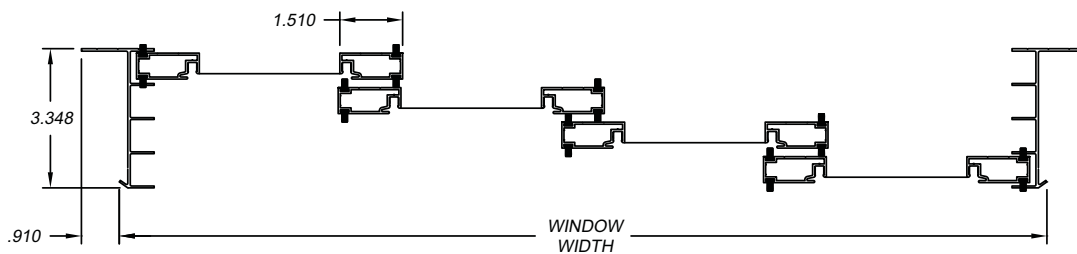

STANDARD FEATURES

- Outside mount frame
- Aluminum extruded main frame
- White frame color
- 2-track frame depth 1-5/8"
- 4-track frame depth 3-3/8"
- 7/8" front installation flange
- Sill without flange and threshold both sides
- Glazed with 1814 charcoal screen mesh
- Equal removable vents
- Swivel latches sent for field installation
- Spreader bar(s)
- Neoprene rollers
- Factory installed thumb pulls
- Sizing
 - Opening size with 1/8" deduction in width & height

OPTIONAL FEATURES

- Bronze, beige, or pebble khaki (driftwood) frame color
- Clear, bronze, dark gray, or smoke gray 10-mil vinyl color
- BetterVue® 2020, SunScreen®, and 1816 screen mesh
- Kickplate 8, 12" or 16"
- Unequal vents
- Pull handle
- Threshold one side or none
- Configurations with up to 10 vents
- Stacked, staggered, pyramid, condo, and pocket configurations
- Standard or reverse stack
- Factory installed swivel latches or none
- Sizing
 - Opening size with a 1/4" deduction in width & height
 - Actual unit size with no deductions

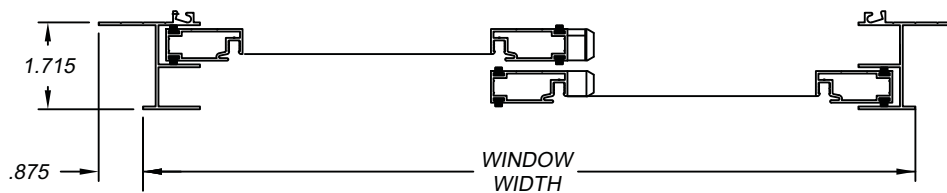
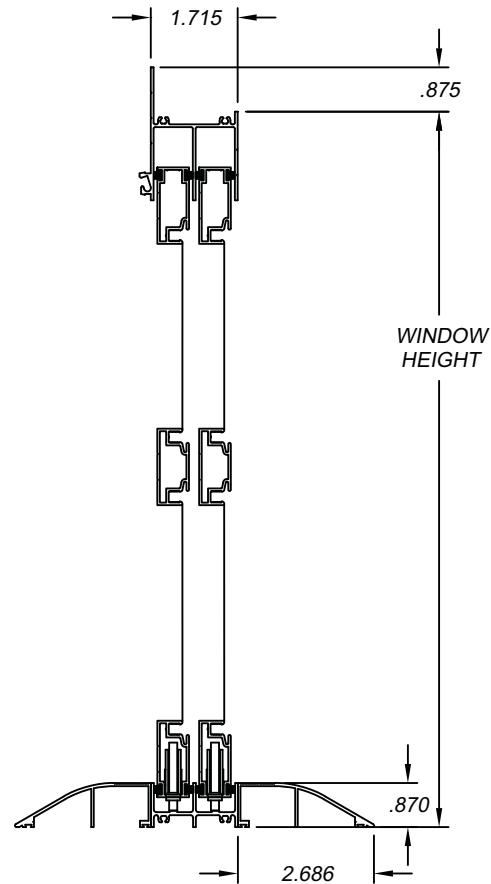



Horizontal Side Slider Garage Door Screen

Series SS30

Outside Mount Guidelines

Information necessary for a complete and correct quote/order:

	Example:	Example:	Example:
1. Product / series number	SS30	SS30	SS30
2. Track quantity	2 track	4 track	4 track
3. Vent quantity	2 vent	4 vent	10 vent
4. Installation frame type	OSM	OSM	OSM
5. Size selection	Opening with 1/8" cutback	Opening with 1/4" cutback	Actual (No deductions)
6. Size	46" x 79 1/2"	165" x 82"	240" x 98"
7. Unit configuration	Standard	Standard	Standard
8. Vent configuration	Stacked	Pyramid	Staggered
9. Vent stack	Standard	Standard	Reverse
10. Frame color	White	Beige	Pebble khaki
11. Vent glazing	Screen	Vinyl	Screen
12. Vinyl color or screen options	1814C	Smoke gray	BetterVue 2020
13. Spreader bar quantity	1	1	1
14. Kickplate height	12"	8"	16"
15. Threshold options	On both sides of sill	None	On one side of sill
16. Screen configuration			
17. Screen option			KD unit
18. All other desired options must be included at the time of order			

Note: Options not listed cannot be incorporated into your quote or order

Additional order and product information:

- Opening measurement is preferred:** Our standard cutback (deduction) is 1/8" and will be taken in both width and height. You may choose one of our other options: 1/4" cutback or actual unit size (not including installation flange).
- To ensure exceptional product performance and functionality, spreader bars are required on actual unit heights that exceed 48" tall

See 2-Track & 4-Track configuration pages 24 - 27 for minimum and maximum size details.

Horizontal Side Slider Garage Door Screen

Series SS30

Outside Mount Configurations

4- Track Horizontal Side Slider

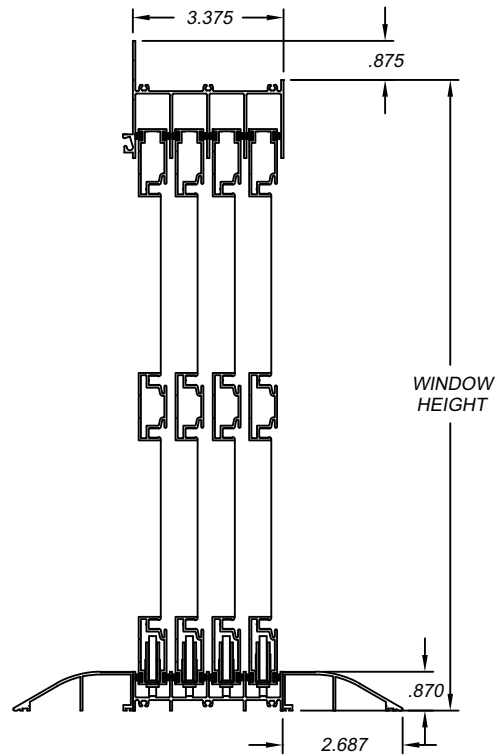

4- Track Horizontal Side Slider

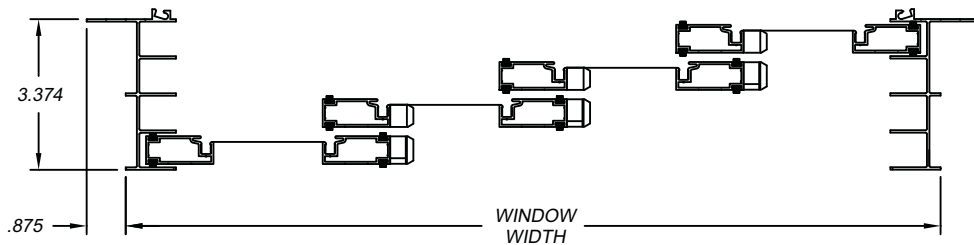

STANDARD FEATURES

- Inside mount frame
- Aluminum extruded main frame
- White frame color
- 2-track frame depth 1-5/8"
- 4-track frame depth 3-3/8"
- 1-1/8" front installation flange
- Sill without flange and threshold both sides
- Glazed with 1814 charcoal screen mesh
- Equal removable vents
- Swivel latches sent for field installation
- Spreader bar(s)
- Neoprene rollers
- Factory installed thumb pulls
- Sizing
 - Opening size with 1/8" deduction in width & height

OPTIONAL FEATURES

- Bronze, beige, or pebble khaki (driftwood) frame color
- Clear, bronze, dark gray, or smoke gray 10-mil vinyl color
- BetterVue® 2020, SunScreen®, and 1816 screen mesh
- Kickplate 8, 12" or 16"
- Unequal vents
- Pull handle
- Threshold one side or none
- Configurations with up to 10 vents
- Stacked, staggered, pyramid, condo, and pocket configurations
- Standard or reversed stack
- Regular or reverse mounting
- Factory installed swivel latches or none
- Sizing
 - Actual unit size with no deductions

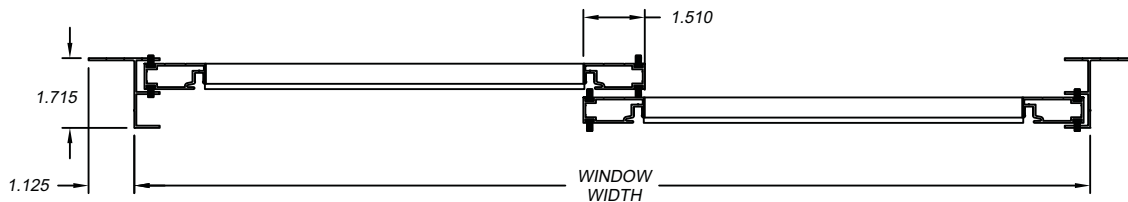
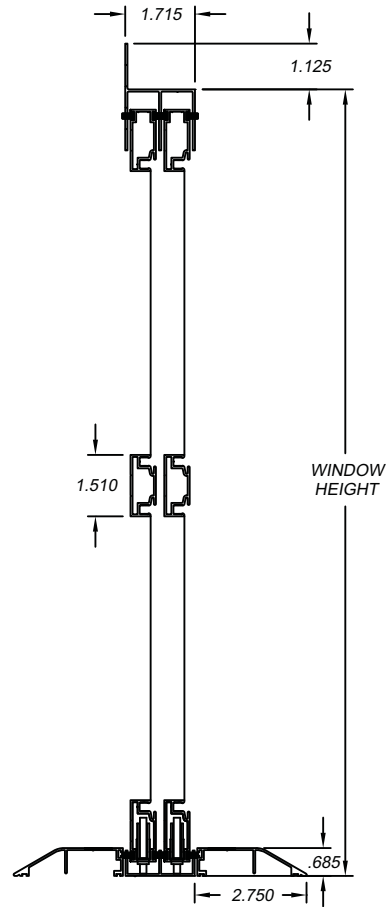



Horizontal Side Slider Garage Door Screen

Series SS30

Inside Mount Guidelines

Information necessary for a complete and correct quote/order:

	Example:	Example:	Example:
1. Product / series number	SS30	SS30	SS30
2. Track quantity	2 track	4 track	4 track
3. Vent quantity	2 vent	4 vent	10 vent
4. Installation frame type	ISM	ISM	ISM
5. Size selection	Opening with 1/4" cutback	Opening with 3/8" cutback	Actual (No deductions)
6. Size	46" x 79 1/2"	165" x 82"	240" x 98"
7. Unit configuration	Standard	Standard	Standard
8. Vent configuration	Stacked	Pyramid	Staggered
9. Vent stack	Standard	Standard	Reverse
10. Frame color	White	Beige	Pebble khaki
11. Vent Glazing	Vinyl	Screen	Mixed vinyl / screen
12. Vinyl color or screen options	Clear	White sunscreen	1814C above the spreader bar and dark gray below the spreader bar
13. Spreader bar quantity	1	1	1
14. Kickplate height	12"	8"	16"
15. Threshold options	None	On both sides	On both sides
16. All other desired options must be included at the time of order			

Note: Options not listed cannot be incorporated into your quote or order

Additional order and product information:

- Opening measurement is preferred:** Our standard cutback (deduction) is 1/4" and will be taken in both width and height. You may also order by actual unit size (not including flange).
- To ensure exceptional product performance and functionality, spreader bars are required on actual unit heights that exceed 48" tall.
- Mounting applications must be specified upon ordering to ensure proper weephole placement. *See page 3 for details.*

See 2-Track & 4-Track configuration pages 24 - 27 for minimum and maximum size details.

Horizontal Side Slider Garage Door Screen

Series SS30

Inside Mount Configurations

4- Track Horizontal Side Slider

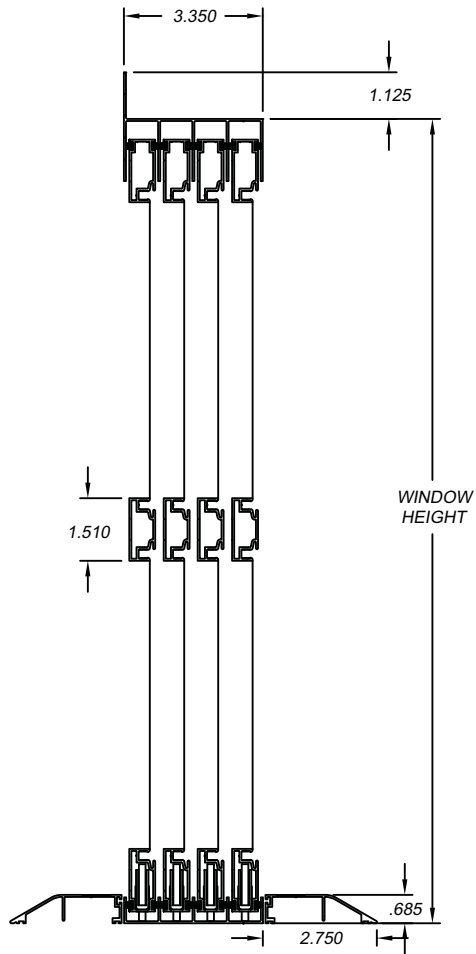

4- Track Horizontal Side Slider

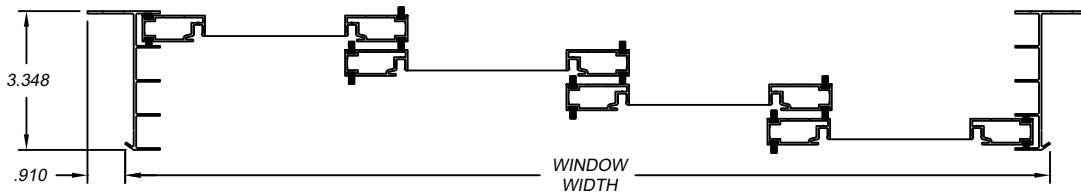



Side Slider 2-Track & 4-Track Configurations

2-TRACK UNIT CONFIGURATIONS - STACKED

Vent Qty/Configuration	Standard Vent Stack	Reverse Vent Stack	Opening Sizes
2 Vent 2T2V Stacked			Min (Vinyl / Screen) 24" x 10" Max w/Vinyl Vents 108" x 108" Max w/Screen Vents 120" x 108"
3 Vent 2T3V Stacked			Min (Vinyl / Screen) 36" x 10" Max w/Vinyl Vents 162" x 108" Max w/Screen Vents 180" x 108"
4 Vent 2T4V Stacked			Min (Vinyl / Screen) 48" x 10" Max w/Vinyl Vents 216" x 108" Max w/Screen Vents 240" x 108"
6 Vent 2T6V Stacked			Min (Vinyl / Screen) 72" x 10" Max w/Vinyl Vents 240" x 108" Max w/Screen Vents 240" x 108"
8 Vent 2T8V Stacked			Min (Vinyl / Screen) 96" x 10" Max w/Vinyl Vents 240" x 108" Max w/Screen Vents 240" x 108"

2-TRACK UNIT CONFIGURATIONS - STAGGERED

Vent Qty/Configuration	Standard Vent Stack	Reverse Vent Stack	Opening Sizes
4 Vent 2T4V Staggered			Min (Vinyl / Screen) 48" x 10" Max w/Vinyl Vents 216" x 108" Max w/Screen Vents 240" x 108"
5 Vent 2T5V Staggered			Min (Vinyl / Screen) 60" x 10" Max w/Vinyl Vents 240" x 108" Max w/Screen Vents 240" x 108"
6 Vent 2T6V Staggered			Min (Vinyl / Screen) 72" x 10" Max w/Vinyl Vents 240" x 108" Max w/Screen Vents 240" x 108"
7 Vent 2T7V Staggered			Min (Vinyl / Screen) 84" x 10" Max w/Vinyl Vents 240" x 108" Max w/Screen Vents 240" x 108"
8 Vent 2T8V Staggered			Min (Vinyl / Screen) 96" x 10" Max w/Vinyl Vents 240" x 108" Max w/Screen Vents 240" x 108"
10 Vent 2T10V Staggered			Min (Vinyl / Screen) 120" x 10" Max w/Vinyl Vents 240" x 108" Max w/Screen Vents 240" x 108"

2-TRACK UNIT CONFIGURATIONS - PYRAMID

Vent Qty/Configuration	Standard Vent Stack	Reverse Vent Stack	Opening Sizes
3 Vent 2T3V Pyramid			Min (Vinyl / Screen) 36" x 10" Max w/Vinyl Vents 162" x 108" Max w/Screen Vents 180" x 108"
4 Vent 2T4V Pyramid			Min (Vinyl / Screen) 48" x 10" Max w/Vinyl Vents 216" x 108" Max w/Screen Vents 240" x 108"
6 Vent 2T6V Pyramid			Min (Vinyl / Screen) 72" x 10" Max w/Vinyl Vents 240" x 108" Max w/Screen Vents 240" x 108"
9 Vent 2T9V Pyramid			Min (Vinyl / Screen) 108" x 10" Max w/Vinyl Vents 240" x 108" Max w/Screen Vents 240" x 108"



Side Slider 2-Track & 4-Track Configurations

2-TRACK UNIT CONFIGURATIONS - CONDO STACKED

Vent Qty/Configuration	Standard Vent Stack	Reverse Vent Stack	Opening Sizes
3 Vent 2T3V Condo Stacked			Min (Vinyl / Screen) 24" x 10" Max (Vinyl Vents) 108" x 108" Max (Screen Vents) 120" x 108"
4 Vent 2T4V Condo Stacked			Min (Vinyl / Screen) 36" x 10" Max w/Vinyl Vents 162" x 108" Max w/Screen Vents 180" x 108"
6 Vent 2T6V Condo Stacked			Min (Vinyl / Screen) 48" x 10" Max w/Vinyl Vents 216" x 108" Max w/Screen Vents 240" x 108"
9 Vent 2T9V Condo Stacked			Min (Vinyl / Screen) 72" x 10" Max w/Vinyl Vents 240" x 108" Max w/Screen Vents 240" x 108"

2-TRACK UNIT CONFIGURATIONS - CONDO STAGGERED

Vent Qty/Configuration	Standard Vent Stack	Reverse Vent Stack	Opening Sizes
6 Vent 2T6V Condo Staggered			Min (Vinyl / Screen) 48" x 10" Max w/Vinyl Vents 216" x 108" Max w/Screen Vents 240" x 108"
9 Vent 2T9V Condo Staggered			Min (Vinyl / Screen) 72" x 10" Max w/Vinyl Vents 240" x 108" Max w/Screen Vents 240" x 108"

2-TRACK UNIT CONFIGURATIONS - CONDO PYRAMID

Vent Qty/Configuration	Standard Vent Stack	Reverse Vent Stack	Opening Sizes
4 Vent 2T4V Condo Pyramid		N/A	Min (Vinyl / Screen) 36" x 10" Max w/Vinyl Vents 162" x 108" Max w/Screen Vents 180" x 108"
6 Vent 2T6V Condo Pyramid		N/A	Min (Vinyl / Screen) 48" x 10" Max w/Vinyl Vents 216" x 108" Max w/Screen Vents 240" x 108"
8 Vent 2T8V Condo Pyramid		N/A	Min (Vinyl / Screen) 72" x 10" Max w/Vinyl Vents 240" x 108" Max w/Screen Vents 240" x 108"

2-TRACK UNIT CONFIGURATIONS - POCKET

Vent Qty/Configuration	Standard Vent Stack	Reverse Vent Stack	Opening Sizes
2 Vent 2T2V Stacked Single Pocket (Viewed from inside - Pocket Left shown)			Min (Vinyl / Screen) 24" x 10" Max w/Vinyl Vents 108" x 108" Max w/Screen Vents 120" x 108"
2 Vent 2T2V Stacked Double Pocket		N/A	Min (Vinyl / Screen) 24" x 10" Max w/Vinyl Vents 108" x 108" Max w/Screen Vents 120" x 108"
3 Vent 2T3V Pyramid Double Pocket		N/A	Min (Vinyl / Screen) 36" x 10" Max w/Vinyl Vents 162" x 108" Max w/Screen Vents 180" x 108"
4 Vent 2T4V Pyramid Double Pocket		N/A	Min (Vinyl / Screen) 48" x 10" Max w/Vinyl Vents 216" x 108" Max w/Screen Vents 240" x 108"

4-TRACK UNIT CONFIGURATIONS - STACKED

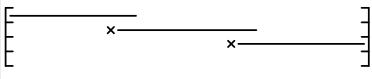
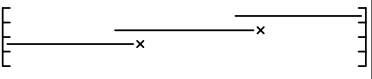
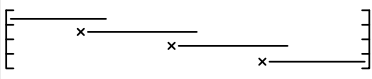
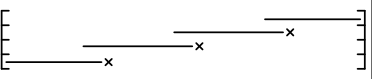
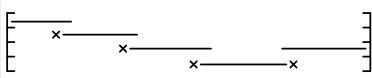
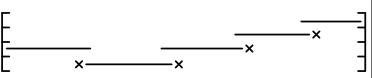
Vent Qty/Configuration	Standard Vent Stack	Reverse Vent Stack	Opening Sizes
3 Vent 4T3V Stacked			Min (Vinyl / Screen) 36" x 10" Max w/Vinyl Vents 162" x 108" Max w/Screen Vents 180" x 108"
4 Vent 4T4V Stacked			Min (Vinyl / Screen) 48" x 10" Max w/Vinyl Vents 216" x 108" Max w/Screen Vents 240" x 108"
5 Vent 4T5V Stacked			Min (Vinyl / Screen) 60" x 10" Max w/Vinyl Vents 240" x 108" Max w/Screen Vents 240" x 108"

4-TRACK UNIT CONFIGURATIONS - PYRAMID

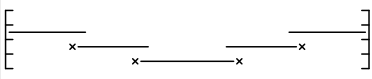
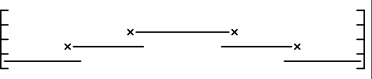
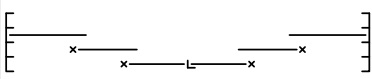
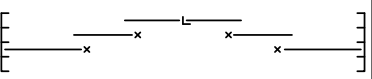
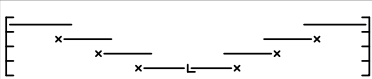
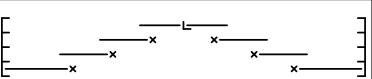
Vent Qty/Configuration	Standard Vent Stack	Reverse Vent Stack	Opening Sizes
5 Vent 4T5V Pyramid			Min (Vinyl / Screen) 72" x 10" Max w/Vinyl Vents 240" x 108" Max w/Screen Vents 240" x 108"
6 Vent 4T6V Pyramid			Min (Vinyl / Screen) 72" x 10" Max w/Vinyl Vents 240" x 108" Max w/Screen Vents 240" x 108"
8 Vent 4T8V Pyramid			Min (Vinyl / Screen) 96" x 10" Max w/Vinyl Vents 240" x 108" Max w/Screen Vents 240" x 108"

4-TRACK UNIT CONFIGURATIONS - CONDO STACKED

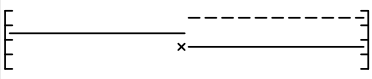
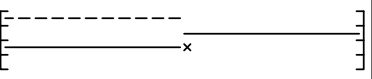
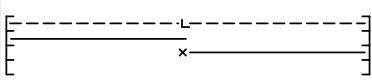
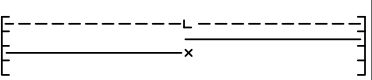
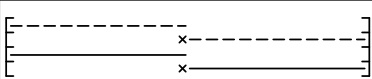
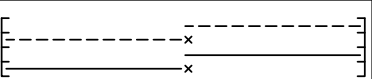
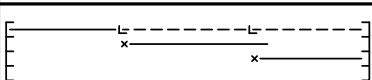
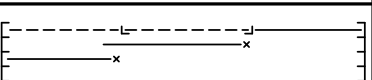
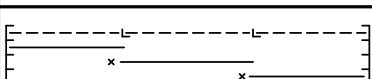
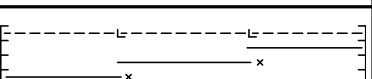
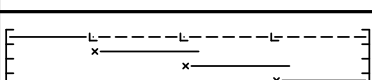
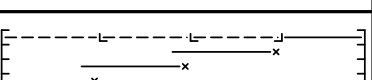
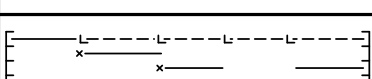
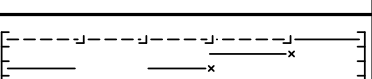
Vent Qty/Configuration	Standard Vent Stack	Reverse Vent Stack	Opening Sizes
3 Vent 4T3V Condo Stacked			Min (Vinyl / Screen) 24" x 10" Max w/Vinyl Vents 108" x 108" Max w/Screen Vents 120" x 108"
4 Vent 4T4V Condo Stacked Fixed Screen			Min (Vinyl / Screen) 24" x 10" Max w/Vinyl Vents 108" x 108" Max w/Screen Vents 120" x 108"
4 Vent 4T4V Condo Stacked Operable Screen			Min (Vinyl / Screen) 24" x 10" Max w/Vinyl Vents 108" x 108" Max w/Screen Vents 120" x 108"
5 Vent 4T5V Condo Stacked			Min (Vinyl / Screen) 60" x 10" Max w/Vinyl Vents 162" x 108" Max w/Screen Vents 240" x 108"
6 Vent 4T6V Condo Stacked			Min (Vinyl / Screen) 72" x 10" Max w/Vinyl Vents 162" x 108" Max w/Screen Vents 240" x 108"
7 Vent 4T7V Condo Stacked			Min (Vinyl / Screen) 72" x 10" Max w/Vinyl Vents 216" x 108" Max w/Screen Vents 240" x 108"
9 Vent 4T9V Condo Stacked			Min (Vinyl / Screen) 108" x 10" Max w/Vinyl Vents 240" x 108" Max w/Screen Vents 240" x 108"



Side Slider 2-Track & 4-Track Configurations

4-TRACK UNIT CONFIGURATIONS - CONDO STAGGERED

Vent Qty/Configuration	Standard Vent Stack	Reverse Vent Stack	Opening Sizes
8 Vent 4T8V Condo Staggered			Min (Vinyl / Screen) 48" x 10" Max w/Vinyl Vents 216" x 108" Max w/Screen Vents 240" x 108"

4-TRACK UNIT CONFIGURATIONS - CONDO PYRAMID

Vent Qty/Configuration	Standard Vent Stack	Reverse Vent Stack	Opening Sizes
6 Vent 4T6V Condo Pyramid		N/A	Min (Vinyl / Screen) 36" x 10" Max w/Vinyl Vents 162" x 108" Max w/Screen Vents 180" x 108"
8 Vent 4T8V Condo Pyramid		N/A	Min (Vinyl / Screen) 60" x 10" Max w/Vinyl Vents 240" x 108" Max w/Screen Vents 240" x 108"
10 Vent 4T10V Condo Pyramid		N/A	Min (Vinyl / Screen) 60" x 10" Max w/Vinyl Vents 240" x 108" Max w/Screen Vents 240" x 108"

4-TRACK UNIT CONFIGURATIONS - POCKET

Vent Qty/Configuration	Standard Vent Stack	Reverse Vent Stack	Opening Sizes
3 Vent 4T3V Stacked Single Pocket (Viewed from inside - Pocket Left shown)			Min (Vinyl / Screen) 36" x 10" Max w/Vinyl Vents 162" x 108" Max w/Screen Vents 180" x 108"
4 Vent 4T4V Stacked Single Pocket (Viewed from inside - Pocket Left shown)			Min (Vinyl / Screen) 48" x 10" Max w/Vinyl Vents 216" x 108" Max w/Screen Vents 240" x 108"
6 Vent 4T6V Pyramid Double Pocket		N/A	Min (Vinyl / Screen) 72" x 10" Max w/Vinyl Vents 240" x 108" Max w/Screen Vents 240" x 108"
8 Vent 4T8V Pyramid Double Pocket		N/A	Min (Vinyl / Screen) 96" x 10" Max w/Vinyl Vents 240" x 108" Max w/Screen Vents 240" x 108"